

## **PLAY SYSTEM**

### **PLAYSYSTEM S15833**

The slide for public playgrounds.

Slide is manufactured in a modern technology of LLDPE rotomolding, which makes it resistant to adverse weather conditions and UV rays. Its large size and light weight ensure fun and safety for the user.

Colours available: yellow, blue, red, green.



# PLAY SYSTEM

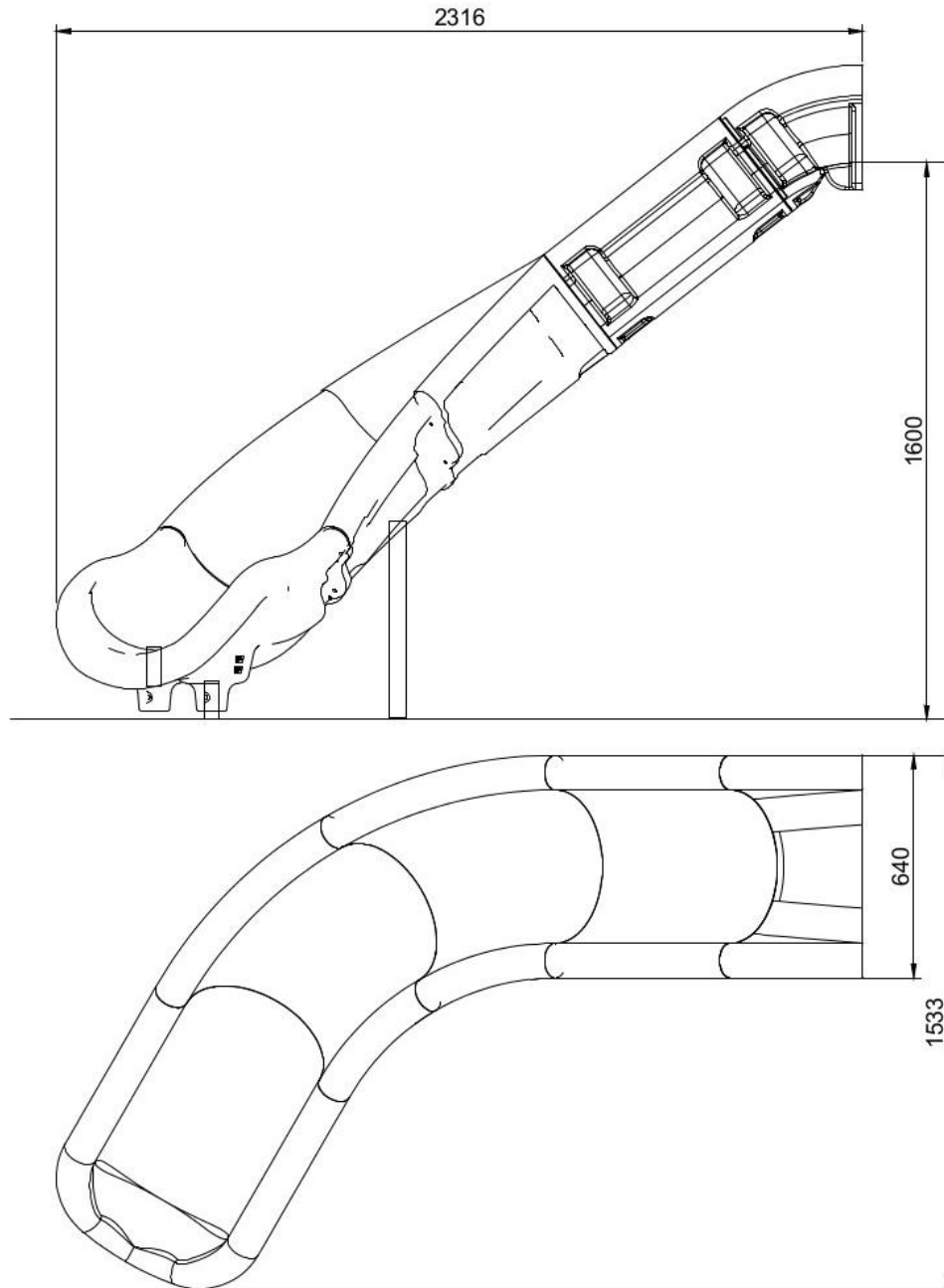

## **Technical data:**

length in plan: 232 cm  
width: 64 cm (dimension in plan: 153 cm),  
platform height: 160 cm,  
safety standards: EN 1176-1; EN 1176-3.

## **Materials:**

Slides made of rotomoulded LLDPE,  
stainless steel nuts, screws.